



BATTLE FOR MERZENHAUSEN, GERMANY **COMPANY G, 119TH INFANTRY REGIMENT, 30TH INFANTRY DIVISION** **20 - 26 NOVEMBER, 1944**

Here are two stories taken from the 119th history book relative to the Battle for Merzenhausen, Germany. Both stories concern members of G Company, 119th Infantry Regiment, 30th Infantry Division...John M. Nolan, of Virginia and Cletus Herrig, of Iowa. Both men joined G Company and were assigned to the 3rd Squad of the 1st Platoon on 6 September, 1944 near Tournai, Belgium. Actually, eight "green" replacements joined the squad that day along with Nolan and Herrig. The other replacements were: Edward Knocke, Ernie King, David Hedland, Bill Cline, Frank O'Leary and Vic Kwaitkowski. During the attack on Freialdenhoven and Merzenhausen, Hedland and O'Leary would be killed and King, Herrig, and Knocke would be wounded. Nolan would nearly be asphyxiated as explained in the copy below.

Hedland, the Squad's BAR man, was killed as the Squad entered the town of Freialdenhoven, just west of Merzenhausen. Knocke was wounded in an embarrassing spot that the men always had a good laugh about. However, the death of Hedland really upset the Squad and they contemplated going out that night to find a German to kill to avenge Hedland's death. Reason won out however and or the fear of getting into big trouble with their superiors kept the Squad from going out that night.

Preceding the Squad's advance into Merzenhausen, they were dug in slit trenches about 1/4 mile from the town. John Nolan was the Platoon Guide and he made sure all men moved forward not backward. Within the Squad was a soldier they called "Pepe"...John J. Pepe. Pepe was as nervous and lost as a soldier could be. He was always needing a hand...from nervously needing tobacco to where to he should go next. But Pepe had an excuse for his actions or lack of because he was punch drunk. Pepe had confessed to Nolan that his "fighting" name was Mickey O'Day" and as Gerry Perrett was to discover many years later, Pepe really was an ex-prize fighter.



Anyway, getting back to their slit trench position, they were getting ready to attack with bayonets fixed and there lay Pepe in his trench, on his back, in the pouring rain. Well Nolan, the Platoon Guide, did get Pepe up and going and as the Squad entered the town they came upon an orchard held by German troops. This orchard was just to the west of the main southern intersection of Merzenhausen. When the German troops saw the GI's attacking with fixed bayonets, they gave up quickly. As it turned out these "Germans" turned out to be conscripted Poles. To the relief of John and the rest of the Squad, Pepe was given the task of walking these 8 Polish POWs back to the prisoner cage. Pepe was never heard from again and we're left to assume that Pepe, toting his M-1, herding his Polish prisoners did get them back to the prisoner cage without incident...So much for Pepe.



The 3rd Squad lead the American advance down the main street of Merzenhausen which was basically the only street. As they stepped into the street and turned to walk down it, a German Panther, (machine guns blazing away) with supporting infantry was coming right at them. O'Leary was killed in the street but King and Herrig quickly ducked into an open door and raced down into the basement of an abandoned house...both of the men were wounded. Nolan and the rest of the Squad ran south ducking in between the town's houses. Nolan located a bazooka team and set it up in an opening between two houses, facing the main street. The opening was about 4 foot wide and the bazooka team patiently waited for the German tank to move by the opening. German tanks were notoriously

quiet and hard to hear in all the noise of battle. It would be about a 20 or 30 foot shot but as the tank passed the opening, the bazooka would not fire. Apparently the battery was dead. There is no question in Nolan's mind that one shot would have turned the German tank a burning inferno if the bazooka had worked. So, without a working bazooka, they had to hightail it out of the house they were hiding in.

Getting back to Herrig and King, still hiding in the basement, Herrig had been hit in the left leg but not seriously but King had been hit in the groin and was in bad shape. Herrig's only thought was "this is it...the end"...there was no getting out of this situation. They both believed that it was going to be either death or becoming a POW. While they hid in the basement, they heard the Germans enter the house and to their dismay, that's where the Germans stayed the entire night. The German troops even shined their flashlights down into the basement at one point but the two GI's were not to be discovered. Herrig and King knew they had to be as quiet as they had ever been in their entire life. King was in fear of bleeding to death and thought maybe they should just surrender but Herrig's concern was that a German hand grenade would come rolling down the stairs. To top off both of their concerns, a German tank had pulled up close to the house, parked and the basement wall just about caved in on the two men! Frightful hour after hour passed until the next morning when the men heard voices coming from upstairs and to their utter joy, realized they were American voices. Herrig and King were hauled out of the basement by American GI's and taken back to the CP for a hot dinner...and what a dinner it was! The day they were saved was Thanksgiving and it was a Thanksgiving feast that Cletus Herrig will NEVER forget and to this day will forever be thankful for.



In another incident, John Nolan was very nearly asphyxiated 24 November, 1944. German civilians or soldiers had built many 'homemade' bunkers on the plains of the Roer River and these were most likely shelters from artillery and mortar fire. They were big enough for 4 or 5 men. The shelters were dug into the earth, covered with timbers, then a layer of straw, another perpendicular layer of timbers and finally covered with dirt. The Company had been driven out of Merzenhausen and was dug in on the surrounding fields. The weather was terrible, wet and muddy, and their M-1 rifles desperately needed a good cleaning. The men were rotated back to this bunker so they could clean their weapons and once inside a canvas 'door' was closed to completely block any light escaping to give away their position. A bayonet was stuck into the dirt wall and candles were placed on blades to give them light. A sound wire phone had been placed in the bunker, which would as it turned out, save the men's lives. About 2:00 or 3:00 o' clock in the morning, all the men gathered in the bunker had fallen asleep. What they didn't realize was, one of the candles fell setting the damp straw into a smoldering fire and that fire flat out sucked up almost all of the oxygen in the bunker. Nolan happened to awake but could barely move because of lack of oxygen. He was able, however, to reach the headset of the phone and call for help. Fortunately, all the men survived but Nolan was taken to a field hospital to recover. His hospital stay was not without incident however. When he entered the hospital, he was wearing up to three layers of long-johns. Once admitted, he had to shed his three layers but when he was released from the hospital, he was given only one pair of long-johns. Nolan was back in the Company within a week, but he was not at all happy about losing his layers of long-johns.

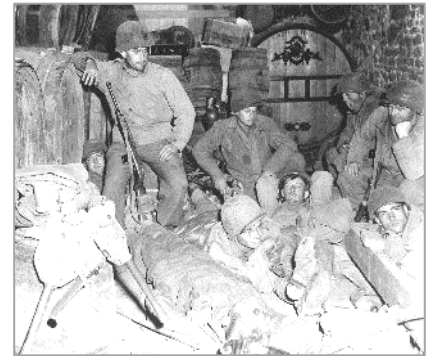

1st Platoon, Company G, 119th Infantry Regiment, 30th Infantry Division - January 5, 1945





30th HBCT Officer Killed in Afghanistan



RALEIGH, N.C. – North Carolina National Guard 1st Lt. Ashley White, 24, of Raeford, N.C., died Saturday, October 22, 2011, near Kandahar, Afghanistan, as a result of wounds she sustained when multiple improvised explosive devices were detonated near her position.



"We are grieving with her family today. Our prayers are with them during this difficult time," said Maj. Gen. Greg Lusk, Adjutant General of North Carolina and Commander of the nearly 12,000 men and women of the North Carolina National Guard. "She was a fine soldier who never shied away from the tough jobs. We will miss her."

White was assigned to the Guard's Goldsboro-based Company C, 230th Brigade Support Battalion of the 30th Heavy Brigade Combat Team. At the time of her death, she was serving with Special Operations Forces as part of a Cultural Support Team (CST), a mission for which she had volunteered.

Soldiers who volunteer for CST duty complete a six-week training course before receiving an assignment with a special operations unit. CST Soldiers are volunteers from across the active and reserve components who are specially assessed, selected, and trained to provide mission support outside their normal military occupational specialty. They are taught special skills that prepare them to interact with women and children in the operational area, as well as advanced individual soldier skills including first aid and weapons training.

Hundreds attended 1st Lt. Ashley White's funeral mass held on October 31st. The overcast skies opened and the bright sun shone through on a cold, blustery day as a military honor guard carried the body of 1st Lt. Ashley Irene White down the steps of St. Joseph Catholic Church to a black, horse-drawn hearse waiting to take this fallen hero to her final resting place. Many of the funeral attendees wiped away tears as they waved American flags, held their hands over their hearts or saluted as the hearse bearing her body drove past rolling farmland and trees full of fall foliage. "She was very strong in her faith," said her sister Brittany. "She died with a faith card in one pocket and her rosary in the other."



Eulogizers told a packed sanctuary about an exceptionally intelligent, athletic, friendly, outgoing and goal-oriented young woman who was full of drive, ambition and concern for others. White's husband, CPT Jason Stumpf, told the congregation about calling home from his own deployment in Southwest Asia and venting his frustrations to a patient and understanding bride. He said she always wore a smile when he arrived at the door of the home they shared in Raeford, N.C. Five minutes with Ashley, he added, would erase the problems of the hardest work day.

A group formed a circle around the grave, the honor guard conveyed the casket to a perch in front of White's family as motorcyclists from the Patriot Guard Riders stood vigil on a hill above the mourners, the American flags in their hands vigorously flapping in the cool wind. Priests and an Army chaplain then said the final words of the funeral service, a presiding Officer presented 1st Lt. White's parents and husband with a folded U.S. flag expressing condolences and "the thanks of a grateful nation. The service concluded with the sharp reports of a 21- gun salute and the sounding of "Taps" played by a military bugler.



Charles "Wes" Morrison Promoted to LTC

One of the OHA's most illustrious members, Wes Morrison, was formally promoted to Lieutenant Colonel at 1100 HRS, 4 November 2011 at the Historical Flag display, 3rd Floor of the new JFHQ building on Gold Star Drive in Raleigh, NC. The pinning ceremony was attended by a Wes's immediate family, a large group of Guard friends and admirers including, MG Greg Lusk, COL Cliff Wilkins, COL Randy Powell, CAPT Kevin Hinton, CAPT Melissa Culbreth, 1SG Russell Prince, SFC Jerry Jackson, SSG Jimmy Nance , 30th IDA President Frank Deegan, OHA members Jay Callaham, Ken Hyatt, Walt Sowinski, Mike Owens (who was accompanied by his wife Holly) and multitudes of other NC National Guard friends and local dignitaries too numerous to mention.



COL Wilkins did a superb job of setting the stage for MG Lusk to recount why Wes was so deservedly being recognized and promoted. The General's short but "accomplishments loaded" speech

served to underscore that the promotion is in recognition of Wes's outstanding service in the Guard. MG Lusk made it very clear to the assemblage that he expected Wes would continue his excellent contribution to the service and continue to be a valuable asset to the NCNG.



When finally at the podium, LTC Morrison thanked everyone for their very kind comments but stated with great emotion, that without the support of his wife Xena,, this event would never have been possible. Wes went on to say that many, many others, including his parents and in-laws, were instrumental in helping him in his career but had to emphasize that his wife Xena was the "rock" that deserved the greatest recognition and his appreciation.

The pinning ceremony was then followed by a tasty buffet food and refreshments gathering which was held in the brand new cafeteria on the 1st floor of the new JFHQ building. All in all, it was a wonderful day for a great guy, father, dedicated soldier and a true American patriot.



Congratulations LTC "Wes" Morrison. Old Hickory!

OHA UNIT NEWS

The OHA Rides in Style at the Warsaw, NC Veterans Day Parade

OHA members attending the annual Warsaw Veterans Day parade honoring the Heroes of the 30th were: Mike & Tyler Owens, Ken Hyatt, Walt Sowinski, Jay Callaham, Charlie Noble, Chuck Eatmon, Dan Jutson, new members Lee Falk, Aaron Clark and Bogdan & Robin Gieniewski. The OHA Board had designated this as a "Maximum Effort" event because the town of Warsaw, NC dedicated this year's parade to specifically



honor the 30th ID, "Old Hickory – Their Hometown Heroes." Most of us arrived at the Armory on Friday night so we could set up our displays and arrange our sleeping accommodations. We had to be ready Saturday morning for their 10:00 am parade muster but the parade planners made sure we got a good hot breakfast at the Masonic Hall before the parade started...great chow! The Armory stay was very comfortable and ever so convenient. Early Saturday morning, Dan Jutson showed up with Ed Middleton who represented the 30th ID WWII vets and none other than our newly promoted LTC Wes Morrison arrived to represent the 30th HBCT... Wes was very keen to ride the "track and man the Ma Duece" and Wes knew that Bogdan was going to bring his WWII halftrack, duce and jeep so he and we got to ride instead of having to march. After the parade, we adjourned back to the Armory to man our militaria displays, to answer questions and grab a bite to eat. The event organizers and parade planners asked everyone in a uniform to be

their guest at the Warsaw Fire Department for a BBQ lunch or at the Armory where they served lunch to the local dignitaries. Some of our guys went to view the Duplin County Veterans Museum on Hill Street which was open from 1:00pm until 4:00pm. All in all, we were treated extremely well, our hosts were exceptionally generous, hospitable, helpful and told us they really appreciated having us in the parade.



OHA at the Guilford Courthouse National Military Park Timeline



The OHA mustered seven members to attend the 2011 Guilford Courthouse National Military Park's "History of the American Soldier" timeline display event this November 12th to honor of Veterans Day. Clint Yarbrough, Pat Grogan, Ken Hyatt, Jay Callaham and Walt Sowinski were joined by new OHA members Jody McKay and Aaron Clark to represent service men of WWII. Jay Callaham erected his usual outstanding WWI display which always gets a lot of crowd interest. Clint's engineer display also

commandeered a lot of attendee interest as well. OHA representation for this event has always been pretty decent and this years group was able to continue our tradition. The weather was great, the public attendance was pretty good and the event organizers served up a tasty barbeque lunch for all of us. All in all, it was quite a successful as well as an enjoyable day!

The OHA Honors the "Final Triad Honor Flight – 11 / 11 / 11"

On November 11, 2011, OHA members Jay Callaham, Walt Sowinski, Neil Trivette, Ken Hyatt, and Pat Grogan assembled at the PTI airport at 0630 to welcome the WWII Vets who were to arrive at 0700 for their 0830 flight to Washington, DC to see the WWII monument. We greeted and assisted the veterans from their vehicles, pointed them to the registration area and cheered them on as they arrived to check in for their DC flight. The uniform of the day was M37 wools with tie, overseas cap, '41 jacket, leggings, pistol belt with baton, MP brassard, buffed shoes, trimmed hair and a close shave. We were dressed out as MP's and had fun asking the vets to produce their "travel orders or liberty passes" as we guided them to the registration site. This last flight was billed as the biggest of the big and a true grand finale for the entire program. When the vets returned back to PTI at 8:30pm, the crowd assembled to welcome them back home was enormous. The OHA provided a Color Guard to honor these vets for their very well attended, emotional and final welcome home. Of particular note, Mr. Dallas Garrick of Lexington, NC was on this last group flight. Dallas served in the 117th Infantry Regiment of the 30th Infantry Division. We told Dallas he should consider attending the next 30th IDA reunion. We'll make sure that he gets all the 30th IDA reunion information. In my considered opinion, the OHA accomplished its mission to make this a truly grand and memorable event for these magnificent WWII Veterans.

The 2.36" ROCKET LAUNCHER aka THE "BAZOOKA"

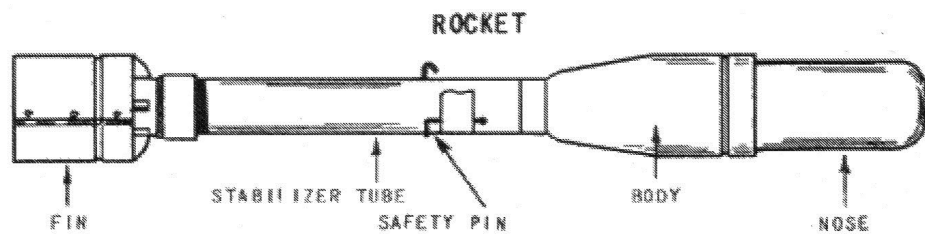
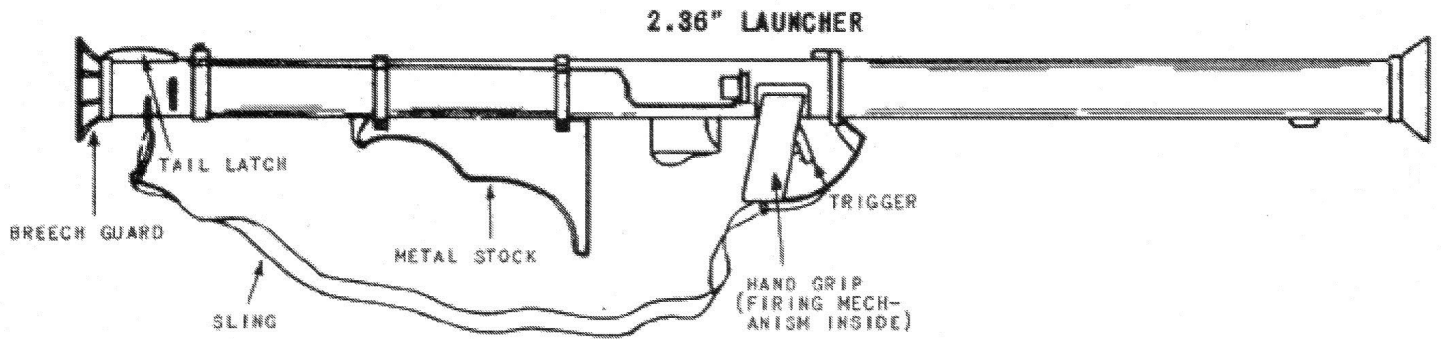

SEQUENCE OF LOADING



1. LOADER GRASPS ROCKET IN LEFT HAND.



2. INSERTS BODY OF ROCKET PARTIALLY INTO LAUNCHER; REMOVES SAFETY PIN.



3. RAISES TAIL LATCH; PUSHES ROCKET COMPLETELY INTO LAUNCHER.

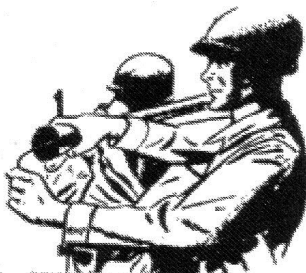

4. REMOVES CONTACT WIRE FROM ROCKET FIN.

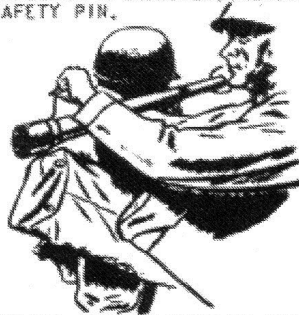

5. AFFIXES CONTACT WIRE TO CONTACT SPRING OF LAUNCHER.



6. TAPS ROCKETEER; CALLS "UP".

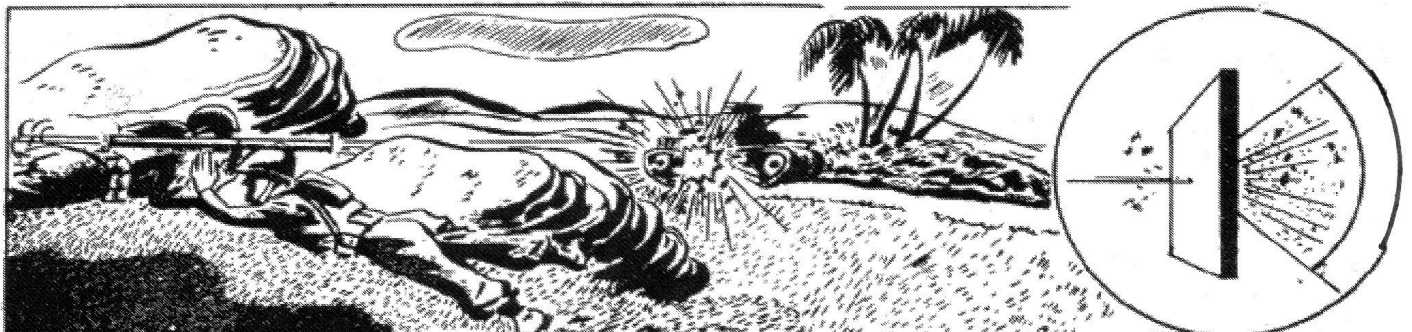

Old Hickory Pin Up

JANUARY

S	M	T	W	T	F	S
1	2	3	4	5	6	7
8	9	10	11	12	13	14
15	16	17	18	19	20	21
22	23	24	25	26	27	28
29	30	31				

FEBRUARY

S	M	T	W	T	F	S
			1	2	3	4
5	6	7	8	9	10	11
12	13	14	15	16	17	18
19	20	21	22	23	24	25
25	26	27	28	29		

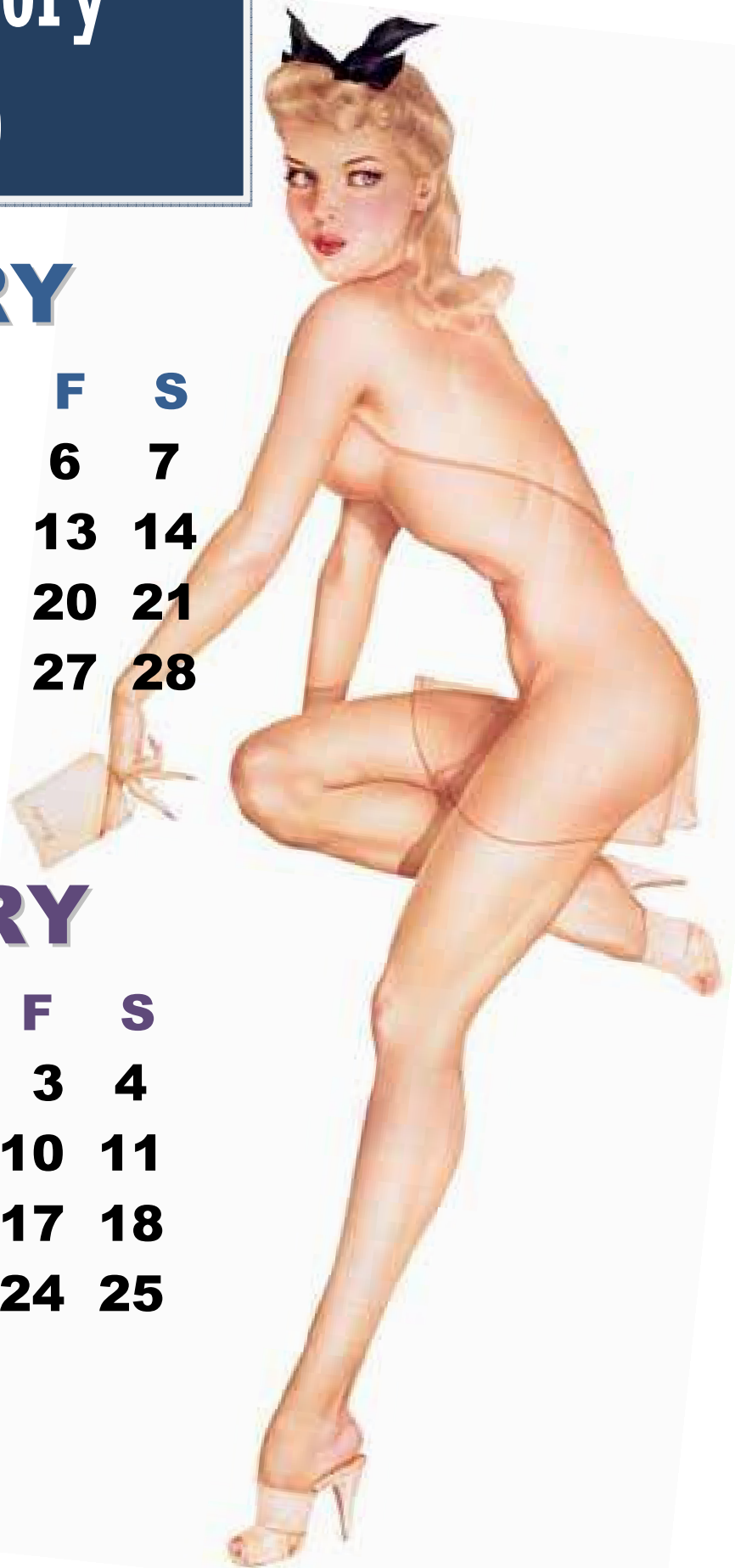



Board of Directors

President

Neil Trivette
336-367-3670

ntrivette@triad.rr.com

Vice-President

Walt Sowinski
336-379-8007

wsowinski@triad.rr.com

Secretary

Brian Illner
864-486-9620

brianillner@hughes.net

Sgt. Of Arms

Jay Callahan
336-854-2008

callahan@bellsouth.net

Director at Large

Clint Yarbrough

42wc21@triad.rr.com

Treasurer:

Jim Higgins

Reenactments / Recruiting
Clint Yarbrough / Charlie Noble

Marksmanship:

Jim Higgins

Drill & Ceremony:

Mark Burfete

Mailing Address:

The Old Hickory Association
P.O. Box 1079
Wake Forest, NC 27588-1079

OHA Website:

www.ohdhickoryassoc.org

Newsletter Editor:

Walt Sowinski

Email: wsowinski@triad.rr.com

Items For Sale

OHA Items:

Grey T-shirt w/OHA logo, S-XL \$10., XXL \$12.50 Golf Shirt, White or Grey, w/ OHA logo, S-XL \$22.50 XXL \$25.00 Grey Sweatshirt w/ OHA logo, S-XL \$18.00, XXL \$20.00 Ball Cap, Grey body w/ blue bill w/ OHA logo \$11.00 Prices do NOT include shipping. Brett says to "Order directly" from: Custom Embroidery Company 123 Wooding Ave. Danville, VA 24541 ph. 434-799-3153 Tell them you are an OHA Member.

Reproduction Items:

WWII Reproduction Rations - Complete reproduction of WW2 K ration, C ration and D bars, as well as other such accessories as Foot Powder, Charms, PK Gum, fuel tablets, batteries and much more. Catalog available. . www.angelfire.com/nc/stug or mail to:

Todd Hogan, 225 S. Melville Street, Graham, NC 27253 or you can e-mail me at -thogan@triad.rr.com

World War II Impressions – U.S. Army uniforms and accessories. Catalog available.

7165 Adwen Street, Downey, CA 90241 Fax and Phone – (562) 927-6922

Email at – www.wwiiimpressions.com/contact.htm

What Price Glory – Reproduction uniforms and accessories. No Catalog available.

238-A Commission Street, Salinas, CA 93901 Toll Free Order Line) – (888) 431-2351

Inquiry Line (831) 754-2351 <http://www.whatpriceglory.com/usunif.htm>



Norm Klein Marches In VFW Parade

The photo above shows OHA member, Norm Klein, marching as an escort in the VFW color guard for the Veterans Day parade in Raleigh. Norm was part of the volunteer color guard sponsored by the Fuquay Varina American Legion Post 116. They volunteered to be the Veterans Day Parade color guard in the downtown Raleigh parade. Norm says it was really cold and windy with the 7:30 am temperature being about 36 degrees F. We marched about ½ mile, but it seemed a lot longer. " We were constantly starting and stopping all along the parade route." I guess Norm enjoyed the color guard duty since he's planning to be in the Fuquay Varina color guard for their Christmas Parade which is scheduled for Sunday, December 6th. Maybe the weather will be a little warmer for Norm's marching this time.

Upcoming Events

January 24 - 29 2012

Ft. Indiantown Gap, PA
Battle of the Bulge
www.wwiifederation.org
Contact: Mike Owens

March 1-3, 2012

30th Infantry Division
Veterans of WWII
National Reunion
Savannah, GA
Contact: Neil Trivette

March 9 - 11, 2012

Sons of Valor VI
Camden, SC
www.ablecompany.org

April 7 - 8, 2012

Armies Through Time
All Eras - All Nations
Camden, SC
Contact: Jay Callahan

April 20 - 22, 2012

Great War Spring Offensive
Newville, PA.
Contact: Jay Callahan

May 25 - 27, 2012

Military Through The Ages
Contact: Katherine Lynn
Park Ranger
Kings Mountain National
Military Park - 864-936-7921



30th Infantry Division Veterans of WWII Plan to Invade Savannah, GA 1-3 March, 2012



It's time to sign up for the Annual Reunion of the 30th Infantry Division Veterans of WWII which will be held on 1 -3 March, 2012, at the Hilton Garden Inn, Savannah Airport, 80 Clyde East Martin Drive, Savannah, GA 31408 912-964-5550. This is a top priority effort to join our WWII 30th Veterans as well as their friends and family. Reserve your room pronto so you get the \$89.00 per room rate. We don't have the final breakdown of the meal costs from Frank but we expect to get that information soon. In the past, however, the OHA has elected to only sign up for the Saturday Banquet which is usually about \$35.00. I'm sure we can pay for the food costs once we arrive in Savannah but the rooms must be reserved by February 9, 2012 to get the \$89.00 rate.

Frank Towers and the all the 30th vets are looking forward to seeing as many of you as will be able to come. So, Call - 912-964-5550 to make your Hotel Reservations now! Be sure to mention that you are part of the 30th Infantry Division Veterans of WWII reunion group to get the special \$89.00 rate. Complete reunion info and registration forms are available on our OHA yahoo site and per this newsletter. Guys, it's time to step up to the plate and do our part...let's answer the call for our veteran buddies just as they did 67+ years ago. A great program is being arranged by the Frank's Reunion Committee. So, get the lead out and send in your paperwork now. That is all, carry on. Ski

Pre-Registration Form

30th Infantry Division Veterans of WWII
National Reunion 1 – 3, March 2012
Hilton Garden Inn Savannah Airport
Savannah, GA

Name: _____

Wife or Companion (s): _____

Address: _____

City: _____ State: _____ Zip: _____

Military Unit: _____ Phone _____

E-Mail Address: _____

Registration Includes: Thurs. Evening Reception; Friday Breakfast; Friday Lunch; Friday Dinner; Saturday Breakfast; Saturday Lunch; Saturday Banquet; Sunday Breakfast, and Hospitality.

Please Note any Special or Dietary Needs: _____

Registration Cost will be \$140.00 Per Person. This includes All Taxes & Gratuity.

Make Checks Payable to: " 30th I.D.V. 2012Reunion Comm" .

In the amount of \$140.00 x (No. of Persons) = \$ _____ (Check Amount)

Mail check along with this form to:

"30th I.D.V. 2012 Reunion Comm."
c/o Frank W. Towers
2915 W. SR #235
Brooker, FL 32622-5167

HILTON GARDEN INN AIRPORT

Call: 912-964-5550

The Hilton Garden Inn, Savannah Airport, is located at 80 Clyde E. Martin Dr., Savannah, GA 31408, and is easily accessible from I-95. If you are driving, and are in doubt, please call the hotel directly for accurate driving directions. The Hotel has 290 guest rooms, all newly renovated, and equipped with: mini-fridge, micro-wave oven, remote control TV's, iron and ironing board, hair dryer, and coffee maker with supplies. The hotel offers amenities including an outdoor pool, and fitness center, complimentary auto parking and RV parking, complimentary wired & wireless Internet and remote printing in the business center. Handicapped accessible and non-smoking rooms are available. Please request these special accommodations at the time you make your reservation. Check-in time is 4:00 PM and check-out time is 12:00 Noon.

The Hilton Garden Inn offers Complimentary shuttle service to and from the Savannah Airport. After arrival at the baggage claim area, call the hotel from a phone in this area and the hotel will inform you of the next pick-up time. You may want to consider other transportation services, as space is limited on these complimentary services. The Hotel does not allow 'live-in' parking for RV's.

*****CUT HERE AND MAIL TO THE HOTEL *****

30th INFANTRY DIVISION – HOTEL RESERVATION FORM

Reunion dates: 1 - 3 March 2012

Name: _____ Phone#: _____

(Please Print)

Address: _____

City: _____ State: _____ Zip: _____

Arrival Date: _____ Departure Date: _____

#Of Rooms _____ #OfPeople _____ Smoking: _____ NonSmoking _____

Handicap Room: _____ King Bed _____ 2 Double Beds _____

If room type requested is not available, nearest room type will be assigned. Make sure to get a confirmation # when making reservation by phone.

Rate: \$89.00 +tax (currently 13%) for King or Double. Rate will be honored three days before and after reunion dates, upon availability.

Cut-Off date: 9 February 2012. Reservations received after this date, will be processed on space & rate availability.

Cancellation Policy: Deposit is refundable if reservation is cancelled by 6:00 PM on day of arrival.

All Reservations must be guaranteed by Credit Card, or with a first night's deposit enclosed.

AMEX _____ DINERS _____ VISA _____ MASTERCARD _____ DISCOVER _____

Card Number: _____ Exp.Date _____

Signature: Regardless of Payment _____

OLD HICKORY!